

in 安卓端架构演变

九言科技 阿刘



CONTENTS

1.0

折纸时代

2.0

铜须时代

后2.0

刺金时代

extra

灵魂尽头





1.0

小、快、灵





程序猿



设计狮



产品汪



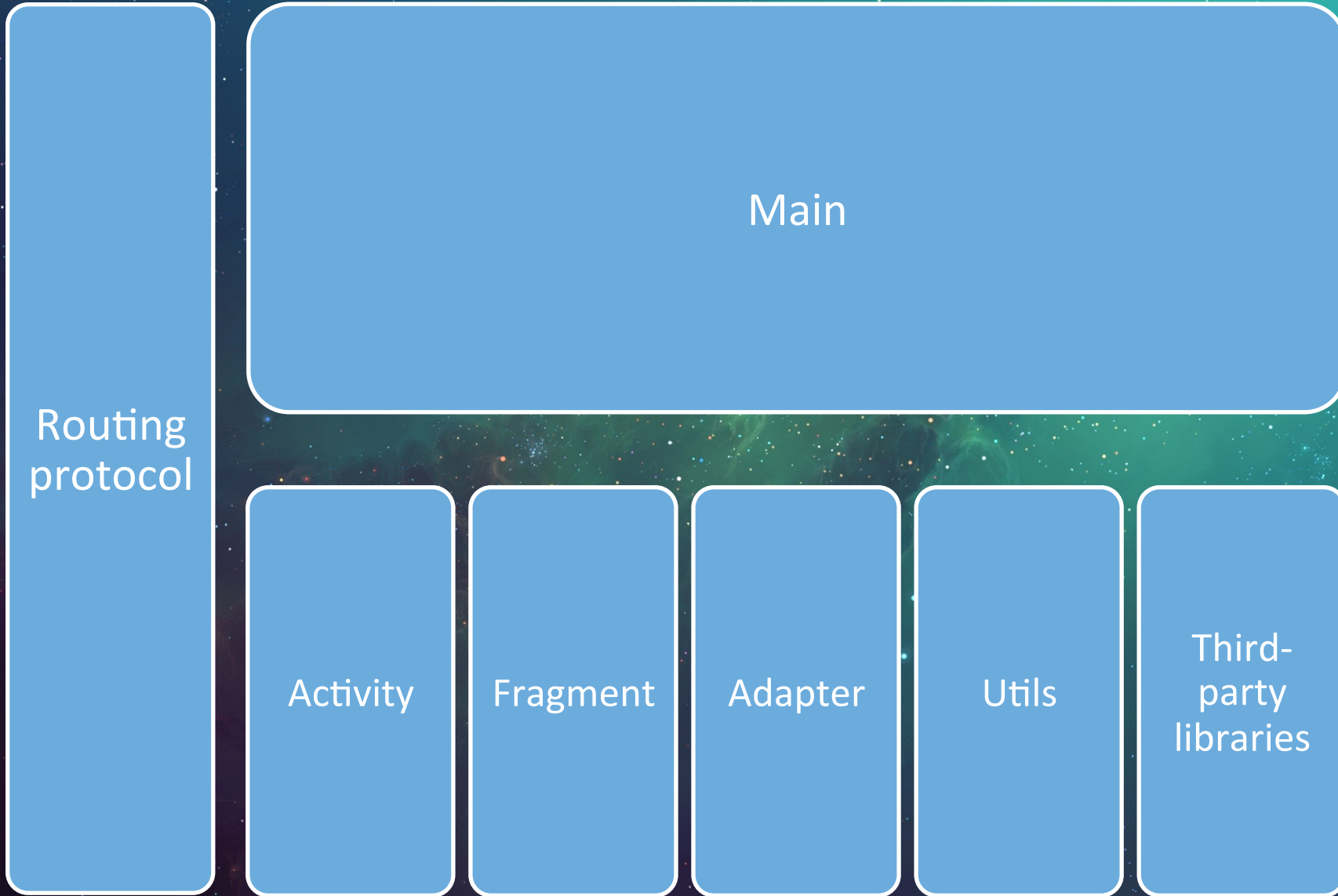

用户量(单位: 万)

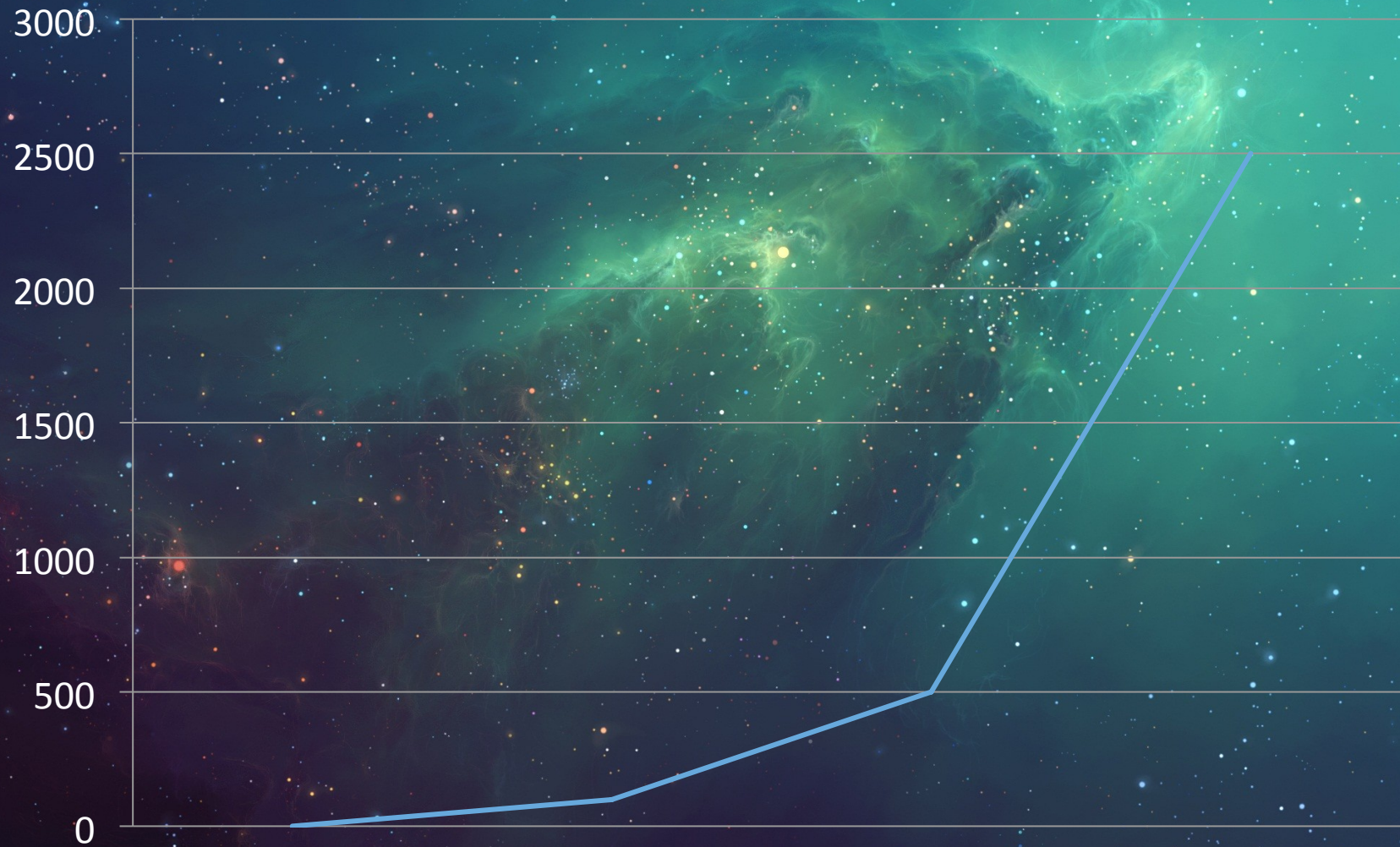

特点
小巧、快捷、灵敏



组织结构
单工程，浅层次结构、直接引用第三方类库



优点

- 结构简洁
- 业务逻辑相对集中
- 代码可读性高，便于排查问题



缺点

扩展性差，个别类臃肿，不适合协同开发





2.0

繁、稳



1. 产品逻辑日趋复杂

2. 代码复用性差

3. 业务逻辑与基础功能杂糅

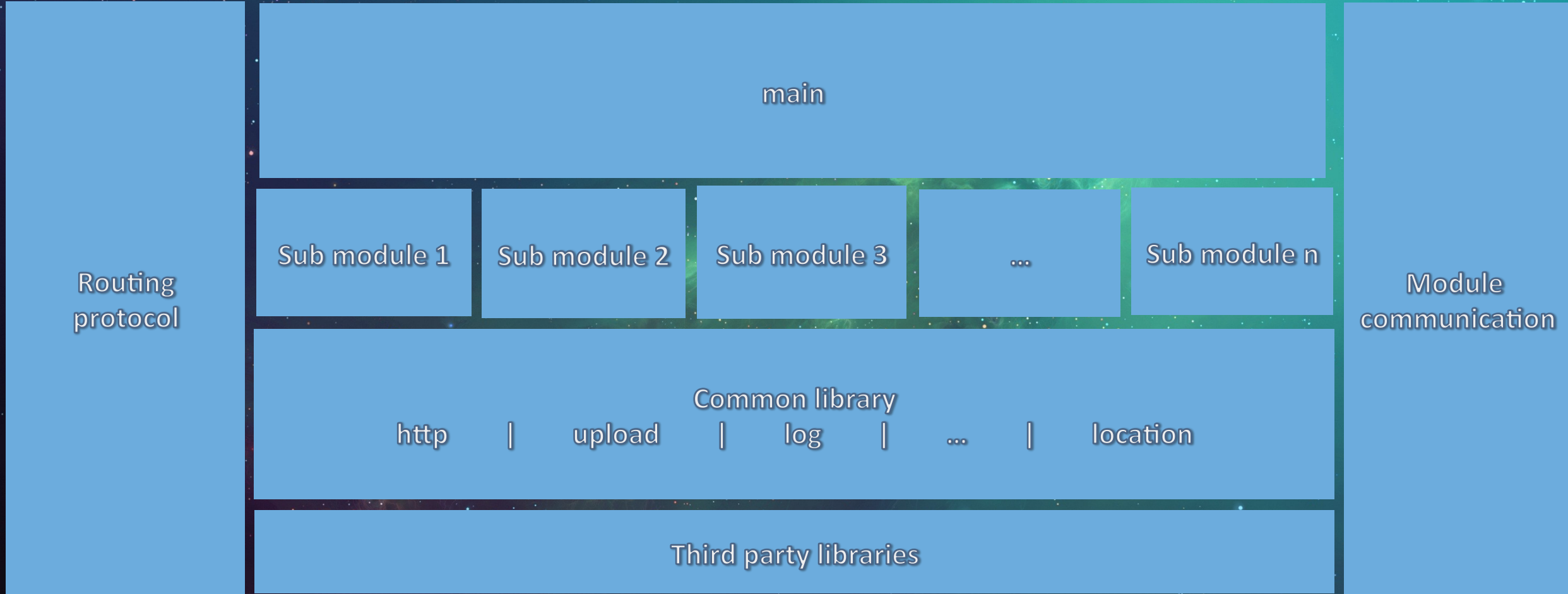



用户量(单位: 万)

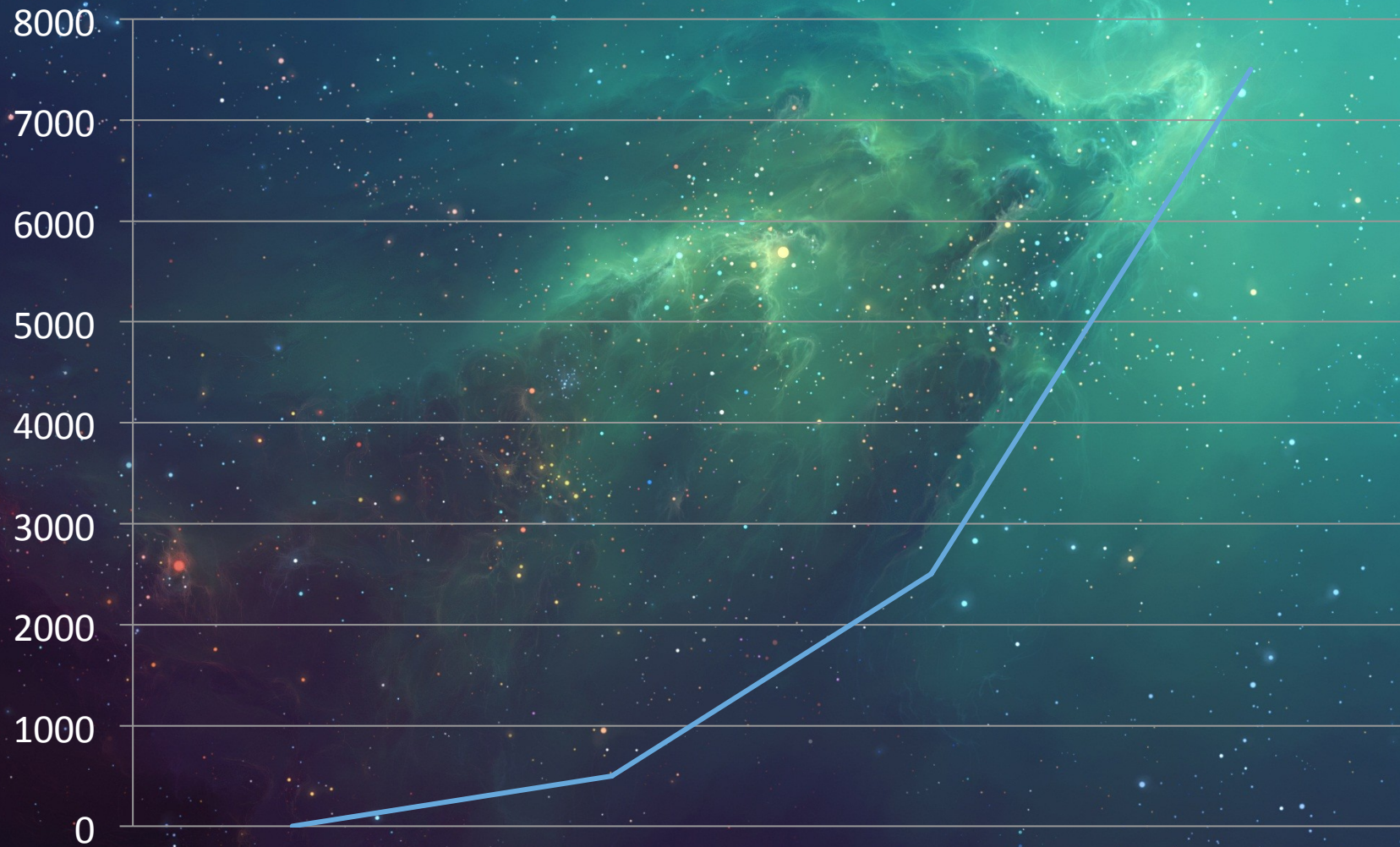

后2.0

精、稳





优点

- 基础功能模块独立
- 隔离第三方类库，便于切换
- 引入业务代理层

特点

从产品角度、研发角度，多方面考量，细分模块

组织结构

业务模块更加细分；公共库中通用功能聚合，独立成单模块，再由代理模块依赖引用





extra

巧、宜



in内统计框架

Page route statistics

Not in Black List

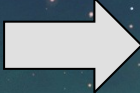
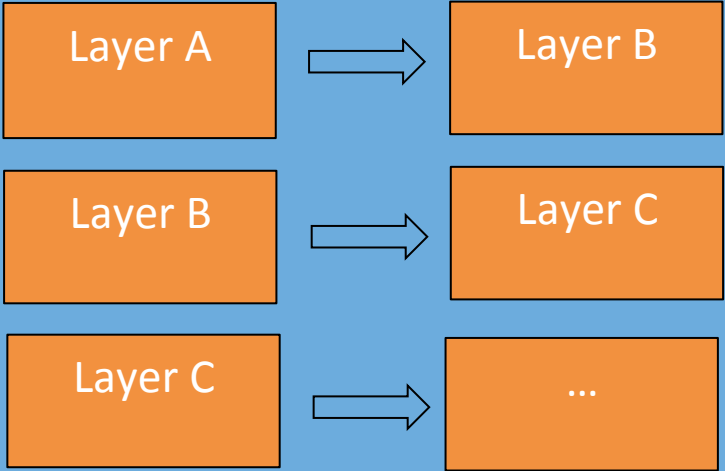

Mapping in server (data repository)

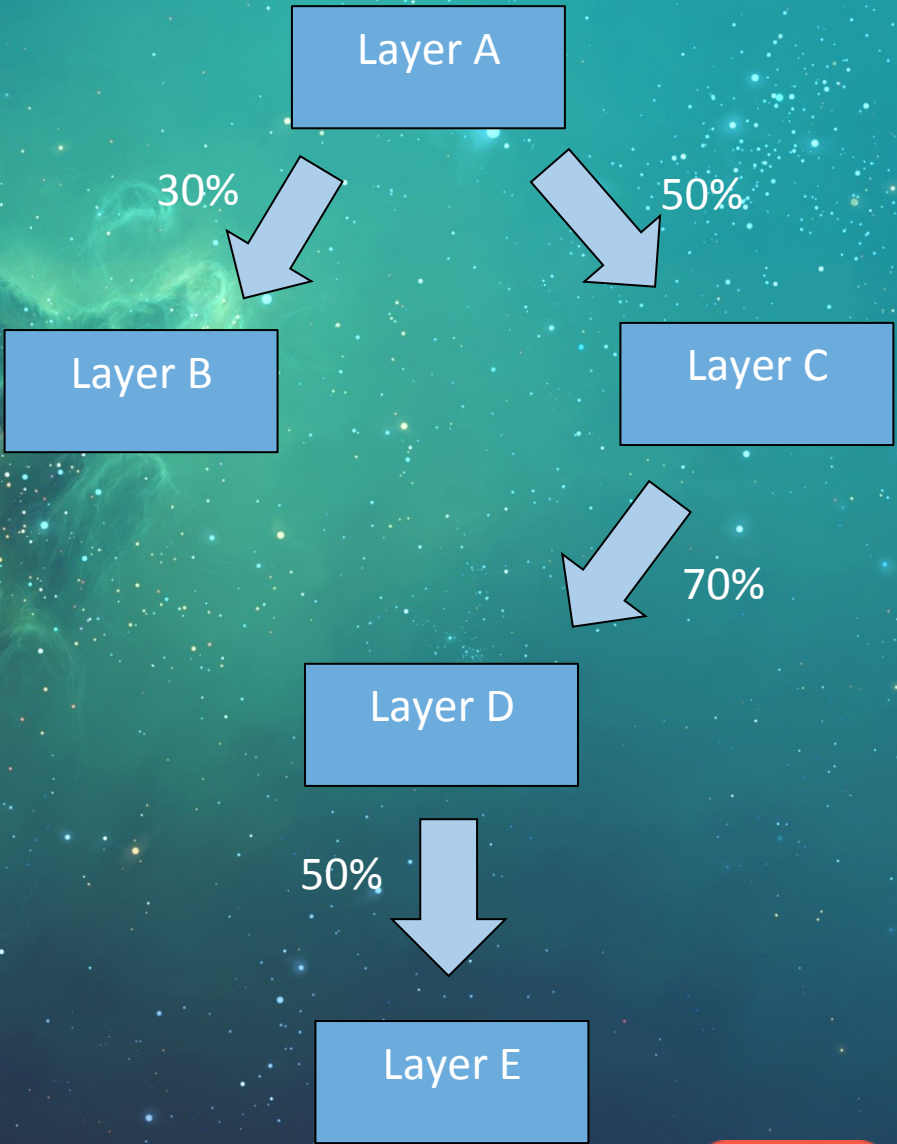
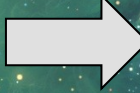

in内统计框架

模块内解耦

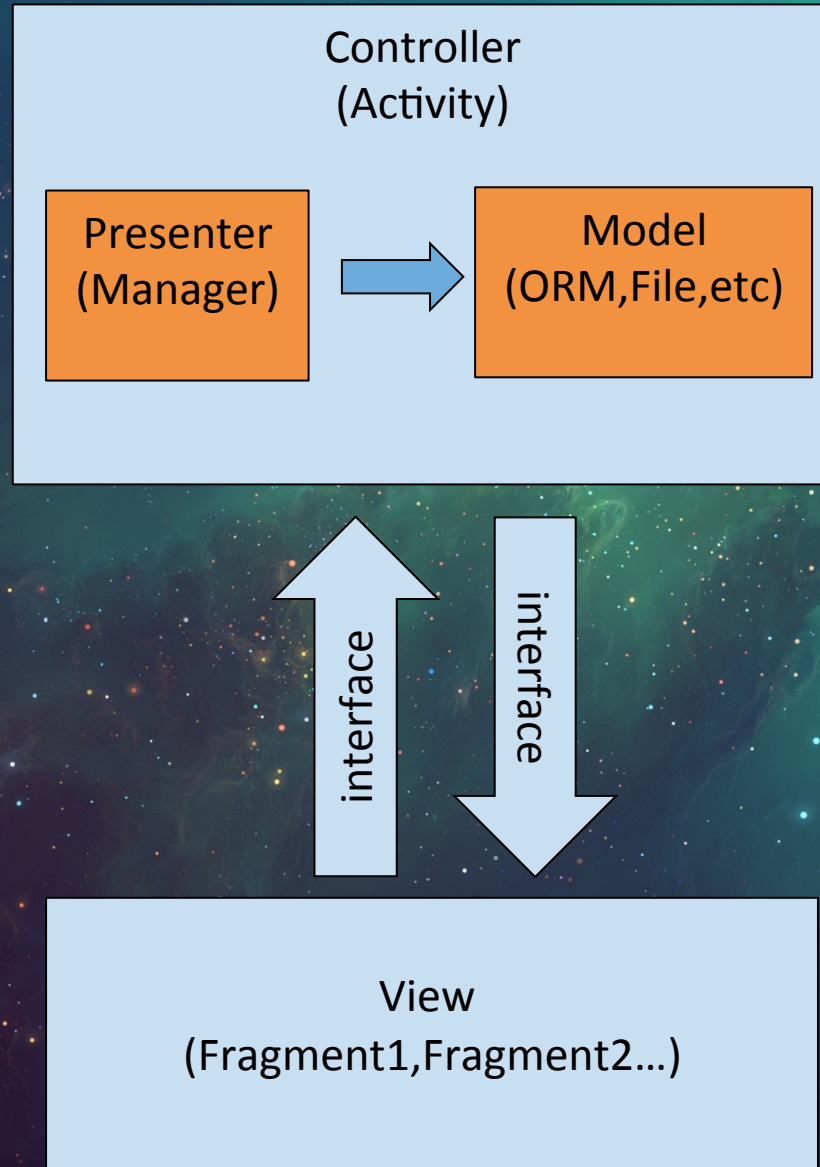

in内统计框架

模块内解耦

灰度发布机制

模块间通信

